

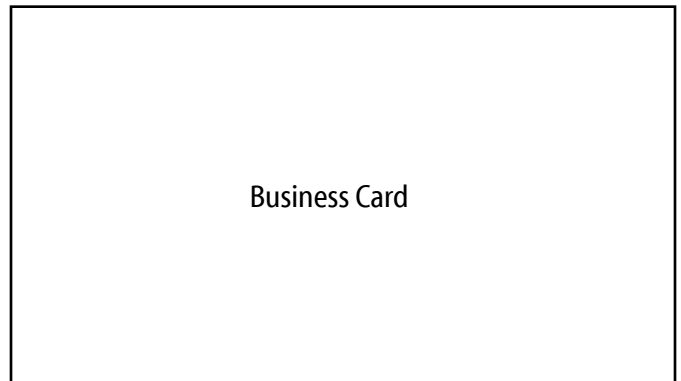

Built for
Life.™



Contact: Precision Pipeline Equipment

Leaders in the World's Strongest Fiberglass Enclosures



Built for Life.TM

Shelter Works[®] makes the world's strongest, longest-lasting fiberglass composite shelters. Our exclusive Fiber Beam Technology[™] bonds the outer and the inner composite surfaces like no other manufacturing process. That means all our products, for all applications, are always backed by a [lifetime guarantee](#). High performance is the result of the relentless pursuit of innovative design technology, expertly applied technical skill and superior communication. Get the power of high performance on your team: if it was built by Shelter Works[®], it was Built for Life[™].

Featuring Our Exclusive

fiber I beam[™]
TECHNOLOGY

strength • performance • reliability

FiberBeam Technology[™] is our innovative composite lamination technique that guarantees superior strength, performance and reliability. This advanced production technique connects the inner and outer composite surfaces with a series of integrated fiberglass beams spaced every 12" throughout the walls, doors and roof. The resulting strength and integrity are unmatched in the industry.



This Shelter Works[®] enclosure survived Hurricanes Katrina and Rita in Sulphur, LA



Call for a free needs assessment and quote today

www.shelterworks.com **800.794.8037** sales@shelterworks.com

Built to Exact Specifications Using Our Exclusive FiberBeam Technology™



**Built for
Life.**™

Innovative Design Technology
Expertly Applied Technical Skill
Superior Communication
Superior Product Appearance
On Budget & On Time Delivery
Superior Field Service



Standard Brick Texture Appearance



Standard Colors
Custom Colors Available

fiberbeam
TECHNOLOGY

strength • performance • reliability

Standard Sizes and Features

Height: 6, 8, or 10ft
Width: 4ft to 16ft
Length: up to 40ft
Hip Roof
Single Door (3' x 6' 8")
R-10 Insulation Value
Submittal Drawings
Choice of Colors
Meets or Exceeds:
30 psf Snow Load
100 mph Wind Load

Benefits

Lifetime Warranty
Maintenance Free
Corrosion Resistant
Weatherproof
Extremely Durable
Insulated
Cost-Effective
Fully Assembled
Easy Installation
Lightweight

Endless Applications

Gas Storage
Well Heads
City Gates
Distribution & Transmission
Instrumentation / SCADA
Regulator Stations
Metering Stations
Odorizer Buildings
Power Generation Equipment

Options

Custom Sizes & Colors
Insulation Value up to R-21
Skids, Bases & Floors
Containment Floors
Molded Openings
Partition Walls & Knock Outs
Mounting Reinforcements
Doors & Hardware
Electrical Packages
Lighting
Windows & Skylights
HVAC Packages
And many more...

Call for a free needs assessment and quote today

www.shelterworks.com **800.794.8037** sales@shelterworks.com

Why Shelter Works® ?

We provide more than just four walls, a roof and a floor- we provide complete turnkey shelter solutions for your specific applications.

When considering a shelter - ask yourself:

(1) What would happen if the shelter, protecting your critical equipment, were to fail?

(2) How significant and far reaching would the resulting damage/costs be?

(3) How can you be assured that the shelter protecting your equipment will provide the needed protection from the most extreme conditions?

At Shelter Works® we think about these issues everyday - all we do is manufacture shelters, and no detail is too small to consider. From our development of the FiberBeam Technology™, to the choice of hardware that we use, every one of our shelters is backed by our exclusive Lifetime Guarantee.



strength • performance • reliability

FiberBeam Technology™ is our proprietary composite lamination technology, producing a structure that is **guaranteed for life**. This advanced production technique connects the inner and outer composite surfaces with a series of integrated fiberglass beams spaced throughout the walls, doors and roof providing steel-like strength. The resulting strength and integrity are unmatched in the industry. This technology has proven survivability in the most severe conditions on the planet: Category 5 hurricane winds in excess of 155 mph, subzero arctic temperatures, extreme snow loads and exposure to constant heat, sun and humidity.

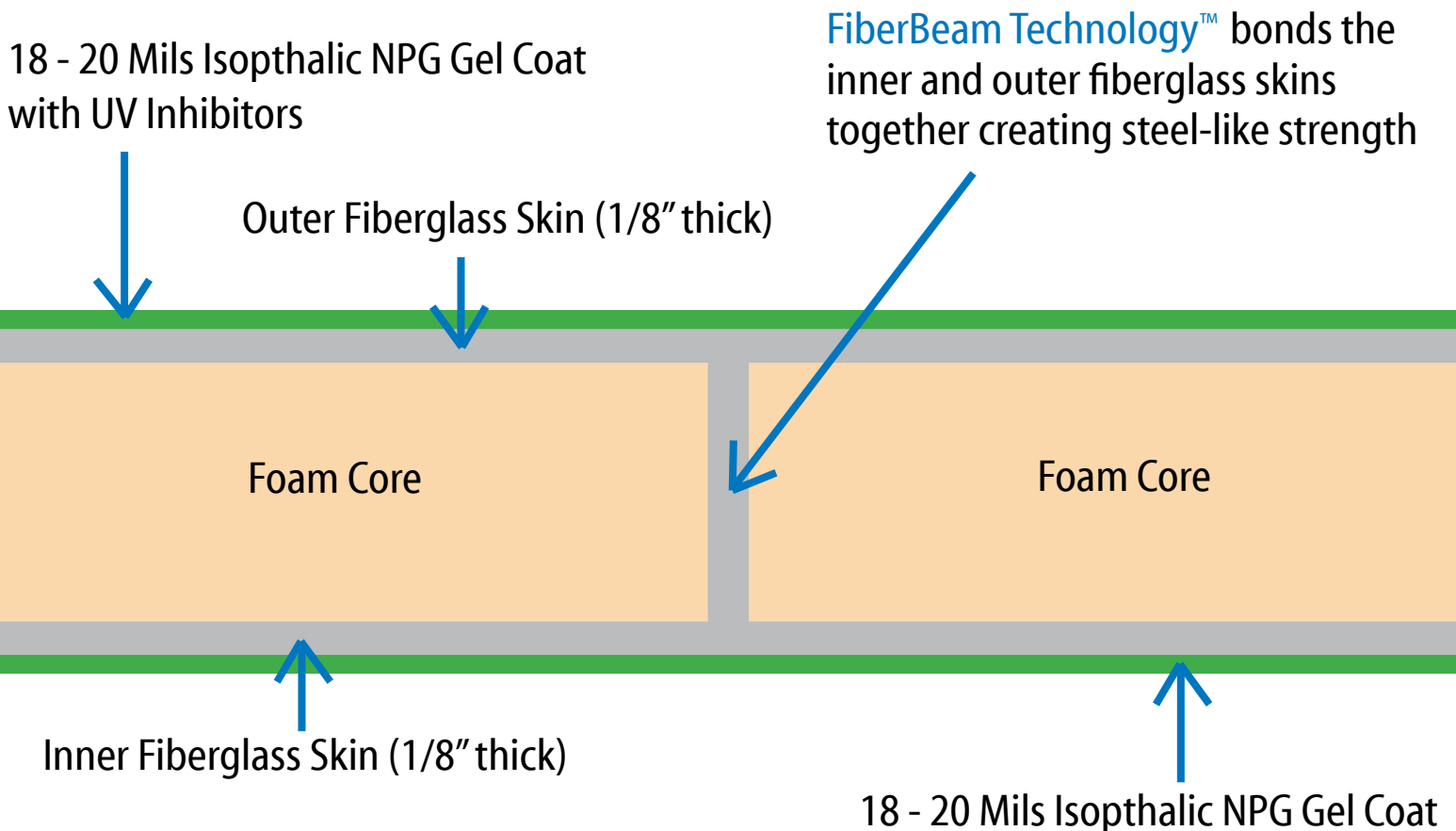

Products



Freedom Series™ Enclosures



Clamshell



Cabinets

Enclosures



Clamshells



Cabinets



Enclosure Features

Limited Lifetime Warranty on Building



Visual Aesthetics





Standard Freedom Series™ Brick Texture Enclosures

Desert Sand	Meadow Green
Polar White	Storm Grey

4 Standard Colors
Custom Colors Available

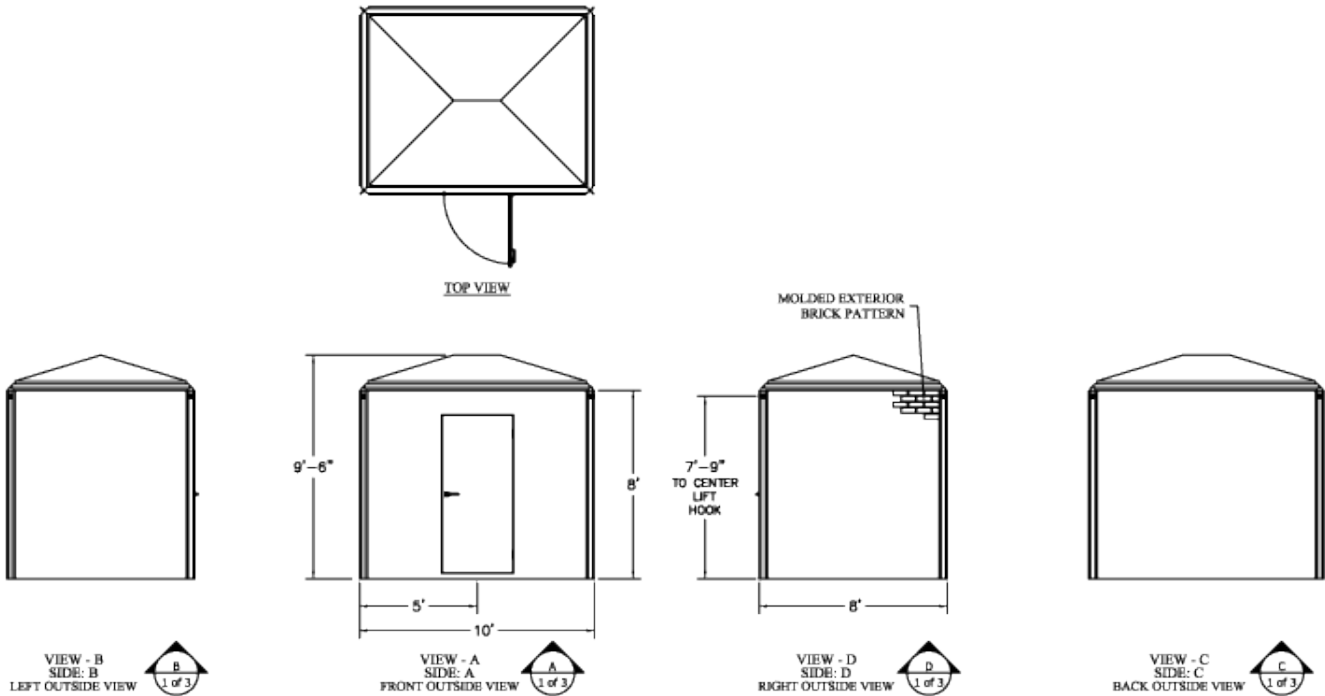
Sample Drawings



		SHELTER WORKS™ 2616 South Third Street, St. Louis, MO 63118 Phone: (800) 794-8037 Fax: (314) 664-9301 www.shelterworks.com	
CUSTOMER: GENERIC PROJECT: - TITLE: 8' x 10' x 8' FREEDOM SERIES™ ENCLOSURE SCALE: 1/4"=1' DWG #: FS-0810-8-ST-GEN	ORDER #: SIZE: B SHEET: 1 OF 3		

REV	DESCRIPTION	BY	DATE
	RATINGS: 30 PSF SNOW LOAD 100 MPH WIND LOAD 1012 LBS APPROX. WEIGHT		
EXTERIOR VIEWS FILE: FS-0810-8-ST-GEN.DWG PLOT SCALE: 1/64 BY: J.G. DATE: 10/19/06		PROPRIETARY TO SHELTER WORKS™ This document is confidential and proprietary to Shelter Works™ and cannot be used, disclosed, copied, or duplicated in any manner without the prior written consent of Shelter Works™. © 2006 Shelter Industries, Inc. All Rights Reserved.	

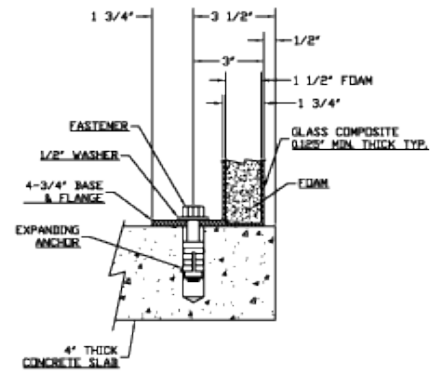
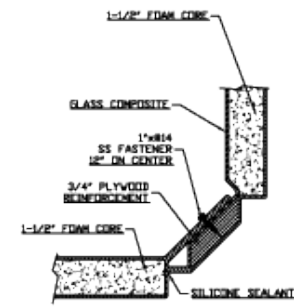
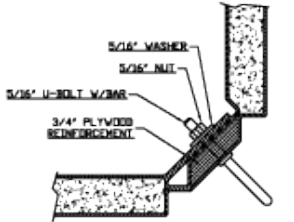
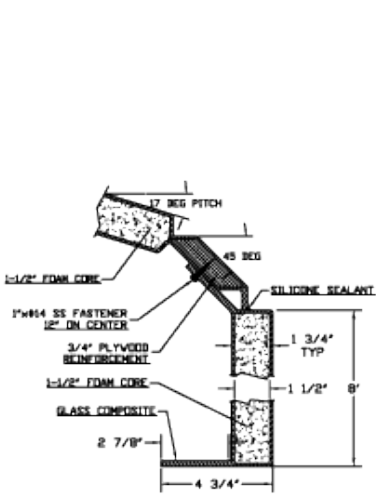

		SHELTER WORKS™ 2616 South Third Street, St. Louis, MO 63118 Phone: (800) 794-8037 Fax: (314) 664-9301 www.shelterworks.com	
CUSTOMER: GENERIC PROJECT: - TITLE: 8' x 10' x 8' FREEDOM SERIES™ ENCLOSURE SCALE: 3/16"=1' DWG #: FS-0810-8-ST-GEN	ORDER #: SIZE: B SHEET: 3 OF 3		

REV	DESCRIPTION	BY	DATE
	RATINGS: 30 PSF SNOW LOAD 100 MPH WIND LOAD 1012 LBS APPROX. WEIGHT		
FASTENING & CONSTRUCTION DETAILS FILE: FS-0810-8-ST-GEN.DWG PLOT SCALE: 1/64 BY: J.G. DATE: 10/19/06		PROPRIETARY TO SHELTER WORKS™ This document is confidential and proprietary to Shelter Works™ and cannot be used, disclosed, copied, or duplicated in any manner without the prior written consent of Shelter Works™. © 2006 Shelter Industries, Inc. All Rights Reserved.	

Product Specifications



GENERAL

1.0 Scope

These general specifications describe the design, materials of construction, fabrication, assembly and characteristics of the standard Freedom Series™ fiberglass composite shelter. Optional features and additional provisions are also outlined.

2.1 Shelter Type

2.1.1 The Freedom Series™ shelter is a durable, corrosion-resistant, molded fiberglass composite structure comprised of four molded wall panels, a molded one-piece roof, and molded door(s). Floors are optional. The standard shelter is pre-assembled but can also be shipped in pieces for easy on-site assembly.

2.2 Standard Sizes

2.2.1 Standard widths are 4 feet to 16 feet in two foot increments. Custom widths are available.

2.2.2 Standard lengths are 6 feet to 24 feet. Custom lengths are available.

2.2.3 Standard wall height is 8 feet. Overall height is relative to the width of the shelter. Custom heights are available.

2.2.4 The inside height is not less than eight feet near the walls. The vaulted inside ceiling height at the peak or ridge is the same as the overall height (less the thickness of the roof, which is typically 1.75").

Height Table

Shelter Width	Shelter Height
4'	8' 10"
6'	9' 2"
8'	9' 6"
10'	9' 9"
12'	10' 0"
14'	10' 0"
16'	10' 0"

2.2.5 A flat ceiling may be integrated as an option.

2.2.6 Custom heights are absolutely available.

2.3 Standard Weights

2.3.1 See table below for approximate weight of each shelter size.

Shelter Works® Freedom Series™ Estimated Weight Chart in Pounds

		Width				
		4'	6'	8'	10'	12'
Length	4'	420				
	6'	500	630			
	8'	580	750	880		
	10'	660	870	1010	1150	
	12'	740	990	1140	1290	1440
	14'	820	1110	1270	1430	1590
	16'	900	1230	1400	1570	1740
	18'	980	1350	1530	1710	1890
	20'	1060	1470	1660	1850	2040
	22'	1140	1590	1790	1990	2190
24'	1220	1710	1920	2130	2340	

Options which will increase the weight of each shelter:

1. Floor systems: fiberglass, wood, aluminum or steel.
2. Additional optional equipment: heaters, A/C units, etc.
3. "Hard Core," the addition of plywood along with the foam core. This is recommended when equipment and fixtures will be attached to the walls, or when extra integrity is required.
4. Additional foam thickness will increase, R-values, and overall weight. The Freedom Series™ has a standard 1.5" foam core, R-10 insulation. See table guide below for specific needs.

2.4 General Assembly

2.4.1 The standard shelter is delivered fully assembled.

2.4.2 Where on-site assembly is required, comprehensive, easy-to-follow assembly instructions are provided or Shelter Works® may be contracted to assemble the shelter(s) on site.

STRUCTURAL

3.1 Finish

3.1.1 All exterior gel coated finishes of the Freedom Series™ shelter are produced in molds, using 18-20 mils of high quality isophthalic NPG gel coat with UV inhibitors. This produces a uniform, imper-

Product Specifications

meable shield which protects against the sun's damaging rays and is free of pinholes or other irregularities which can allow water to penetrate the structure.

3.1.2 The gel coat is pigmented with standard or custom colors and never needs to be painted.

3.1.3 The gel coated finish offers corrosion resistance.

3.1.4 The interior surfaces of the walls and ceiling are coated with a white isophthalic NPG gel coat which makes the shelter interior easy to illuminate and keep clean.

3.2 Walls

3.2.1 The seamless, one-piece walls are composed of a 1.5" thick foam core bonded between two stressed skins of fiber reinforced plastic (FRP), each approximately .125" thick. Total wall thickness is a nominal 1.75". Standard insulation value is R-10.

Our FiberBeamTechnology™ connects the inner and outer composite surfaces with a series of integrated fiberglass beams spaced throughout the walls providing steel-like strength.

3.2.2 Improved wind load and insulation values can be gained by increasing the thickness of the foam core and increasing the number of anchor bolts. This option is called Plus Core and is available in .5" increments.

3.2.3 If heavy equipment is going to be secured to the walls, we recommend that a layer of 1/2" wood sheathing be bonded to the foam core and encapsulated into the wall. This option is called Hard Core and can be utilized in localized areas or throughout the entire structure.

3.2.4 If there is to be a large penetration through the wall (for example, an air conditioner cut out), Shelter Works® will mold the opening, rather than cutting, whenever it is practical to do so. This helps to ensure the lasting integrity of the shelter.

3.2.5 At the base of each wall is a 4.50" wide base flange. This flange folds toward the interior of the shelter and is used for anchoring the shelter to the substratum.

3.2.6 Optional partition walls can be fabricated to divide a shelter into two or more rooms.

3.3 Roof

3.3.1 The roof is a vaulted "hip" design. There are no eaves. A flat ceiling can be incorporated as an option.

3.3.1 The seamless, one-piece roof is composed of a 1.5" thick foam core bonded between two stressed skins of FRP each approximately 1.25" thick. Total roof thickness is a nominal 1.75". Standard insulation value is R-10.

3.3.2 Improved snow load and insulation values can be gained by increasing the thickness of the foam core. This option is called Plus Core and is available in .5" increments up to 4" thick.

Our FiberBeamTechnology™ connects the inner and outer composite surfaces with a series of integrated fiberglass beams spaced throughout the roof providing steel-like strength.

3.3.3 Roof trusses may be molded and integrated into the roof to lend support where needed. The appropriate number of trusses are included to meet the design loads. These trusses may also be used as members from which to suspend items from the roof. Additional trusses may be added as optional equipment and can be strategically placed for convenient outfitting.

3.3.4 If heavy equipment is going to be secured to the ceiling, we recommend that a layer of plywood be bonded to the foam core and encapsulated into the ceiling. This option is called Hard Core and can be utilized in localized areas or over the whole surface of the ceiling.

3.4 Doors

3.4.1 Using the same materials of construction, doors are fabricated by Shelter Works® to be completely compatible with our shelters. A standard door is three foot wide, six foot eight inches high, and 1.75" thick. A door can be placed anywhere on a wall.

Our FiberBeamTechnology™ connects the inner and outer composite surfaces with a series of integrated fiberglass beams spaced throughout the doors providing steel-like strength.

3.4.2 The standard threshold is 2.5" high for easy stepover but can be raised as high as 12" above the floor level to allow for special environmental considerations (such as deep snow), or to allow the bottom portion of the shelter to be used for liquid containment.

3.4.3 Optional trip-proof aluminum threshold is only one-half inch high. This safety feature also allows equipment to be easily wheeled through the doorway.

Product Specifications

3.4.4 Doors can be hung to swing right or left or may be hung as double doors.

3.5 Door Hardware

3.5.1 Each door is hung on (3) 4.5" x 4.5" stainless steel ball bearing hinges with non-removable pins. For tamper resistance, the hinges are oriented in the full-mortised position with no fasteners exposed when the door is closed.

3.5.2 Each door comes with a heavy duty hydraulic door closer. This device prevents the door from opening beyond 95 degrees and allows for shock absorption. An adjustable tension setting allows for the door to be held in the open position until it is firmly pushed to close.

3.5.3 Standard doors are trimmed with a weather-tight neoprene gasket and all doors have a 1" rain drip guard.

3.5.4 The standard latching device is a three-point system which holds the door snugly closed at the top, middle and bottom. A handle is provided on the door which allows the door to be pulled closed from the inside. The cast stainless steel outside lever handle is pad-lockable and tamper resistant. An override safety feature allows an occupant to exit the building if the hardware is locked from the outside.

3.5.5 On double doors only one of the doors receives the hardware described in 3.5.4. The other door is held closed with 2 interior slide bolts.

3.5.6 Single-point cylindrical and modern touch bar panic exit devices are optional.

3.6 Door Jamb

3.6.1 The door jambs are molded as an integral part of the wall.

THERMAL

4.1 Insulation

R-Value Guide

R-Value	R10	R14	R18	R21	R25	R28
Thickness	1.5"	2.0"	2.5"	3.0"	3.5"	4.0"

DESIGN LOADING AND FIRE RETARDANCY

5.1 Snow Load

5.1.1 Standard shelter factory rated for 30lbs of snow load. Higher specifications can be met if required.

5.2 Wind Load

5.2.1 Standard shelter factory rated for 100 mph of wind load. Higher specifications can be met if required.

5.2.2 Shelter must be properly anchored to meet the wind load specification. As an option Shelter Works® will pre-drill the holes in the base flange and provide the proper anchoring devices.

5.3 Floor Loads

5.3.1 Optional floor systems are designed per specifications to meet the load requirements of each application.

5.4 Fire Retardancy

5.4.1 Class I fire and smoke ratings are achievable through the use of special resins and additives. These are optional ratings and are readily available to meet the requirements of your application.

PACKAGED SYSTEMS

6.1 Electrical and HVAC

6.1.1 Shelter Works® offers complete electrical packages. We will factory-install and wire fans, lights, switches, outlets, junction boxes, breaker panels, load centers, alarm systems, etc.

6.1.2 All electrical systems are surface mounted and can be specified in all Classes, Groups, Divisions and NEMA ratings.

6.1.3 Special requirements such as explosion-proof, vapor-proof, corrosion-resistant, weather-tight and foreign-power-compatible systems are also available.

6.1.4 All electrical packages are factory-installed and wired in conformity to the latest edition of the National Electric Code.

6.2 Heating, Ventilating and Air Conditioning

6.2.1 Standard ventilation options include: manual adjustable louvers, exhaust fans, roof turbines, gravity shutters and thermally actuated shutters.

Product Specifications

6.2.2 Shelter Works® offers complete HVAC systems based on the specified requirements of the shelter application.

CUSTOM DESIGNS AND OPTIONS

7.1 Versatility

7.1.1 The Freedom Series™ shelter can be customized to adapt it to the special needs of your application. We enjoy helping our customers find solutions to their enclosure-related challenges.

ADDITIONAL PROVISIONS

8.1 Documentation and Approvals

8.1.1 Prices quoted include basic drawings and documentation. Additional engineering, engineer seals, state approvals, insignias or drawings which may be required by local authorities or others for permitting or other purposes, may or may not be readily available. Whenever possible, Shelter Works® will try to accommodate any such requirements. Please contact Shelter Works® for availability and any additional costs to meet such requirements.

8.2 Shipping

8.2.1 Shelters are shipped via best way, F.O.B. our factory. Quoted delivery costs are estimated and assume normal conditions of accessibility to the destination. Special handling equipment, local permits or requirements are not included in the delivery cost. Off-loading of the shelters shall be the responsibility of others unless otherwise agreed-to in the proposal. Actual delivery charges may differ from quoted estimates to account for actual mileage and special permits.

8.2.2 Items to be attached to the outside of the shelter which cause the shelter to exceed the legal shipping width, such as hoods, air conditioners, etc., will be removed and shipped along with the shelter. Unless other arrangements have been made, it shall be the responsibility of others to reattach or install any such items.

8.2.3 If Purchaser chooses to be responsible for shipping, Shelter Works® will provide insight and guidance to the carrier as to how to secure the load but it shall be the Purchaser's ultimate responsibility that the shelter be delivered in good condition.

8.2.4 Shelter Works® will make every effort to ensure timely delivery. However, Shelter Works® cannot be held responsible for delays in shipping caused by state agencies, weather, mechanical failures or other causes beyond our control.

8.3 Handling

8.3.1 A "Shelter Handling Guide" is provided with each delivery to help the receiving party properly determine how to off-load and handle the shelter until it is set on site.

8.3.2 Shelters are provided with lifting rings so that the shelter can be hoisted up using overhead equipment such as cranes, boom trucks, helicopters and hoists. It is important that all four rings be used for lifting.

8.3.3 If a structural base with lifting rings is attached to the shelter these rings are to be used to lift the shelter rather than those rings bolted through the walls.

8.4 Installation

8.4.1 A "Shelter Installation Guide" is provided with each delivery. If the shelter cannot be installed in one of the approved methods as described in the "Shelter Installation Guide," call Shelter Works® for guidance.

8.5 Warranties

8.5.1 The Shelter Works® Freedom Series™ shelter has a limited lifetime warranty, which covers the materials and workmanship of the enclosure.

8.5.2 The liability on an item purchased by Shelter Works® and factory-installed in a shelter does not exceed the limit of the warranty provided by the manufacturer of the respective item.

