

Contour™



Flow Conditioners

by **Canalta** 

Contour™ K5 Technical Information

Design Time Line, Flow Test Data and Information
Supporting AGA-3 / API 14.3 (2000 Edition) Compliance

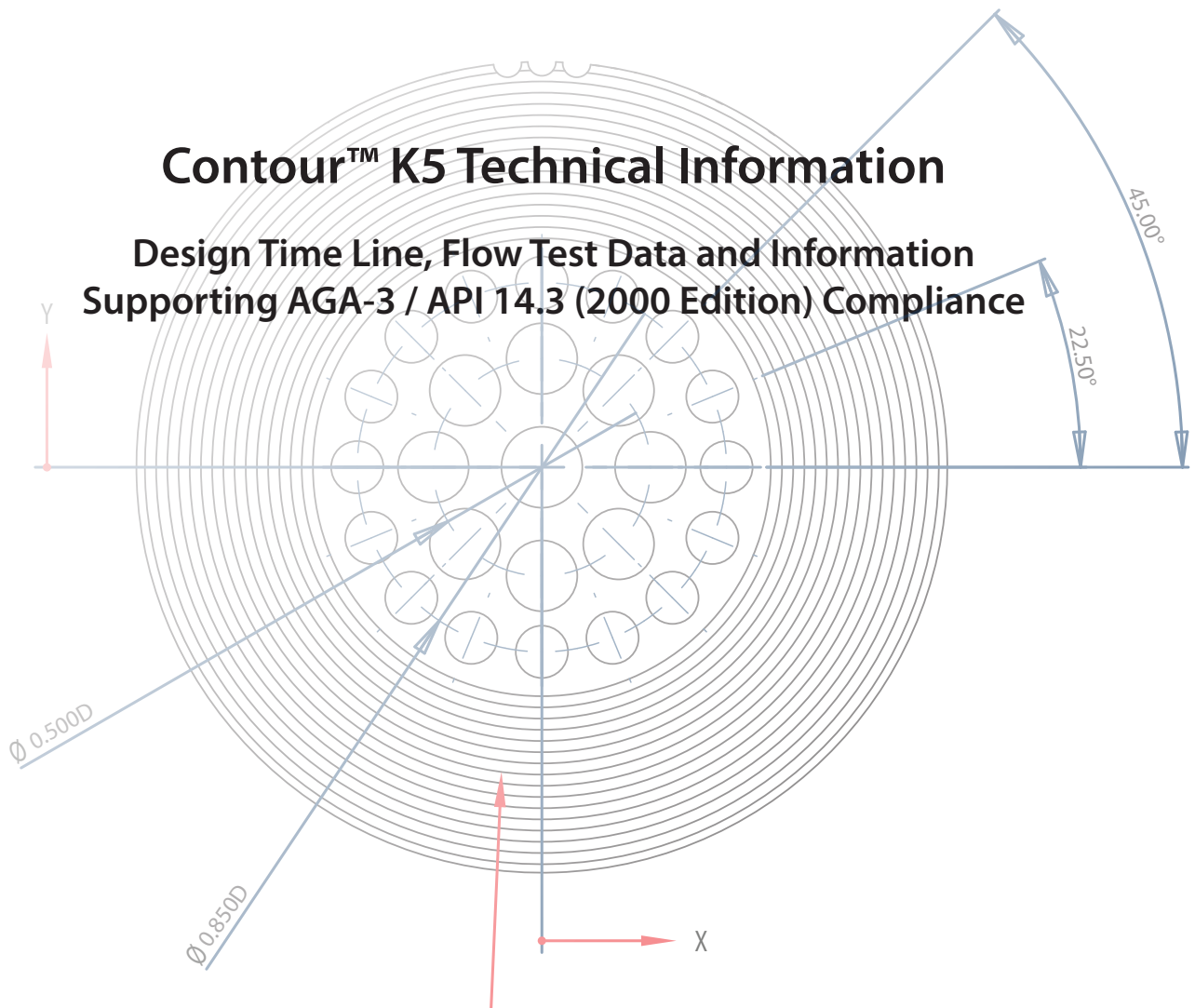

FLANGE FACE SERRATED SPIRAL FINISH OF 125 μ in. TO 250 μ in.
45-55 GROOVES/in (BOTH SIDES).

Canalta

Flow Measurement

A Canalta Controls Company

CALL US TOLL FREE: 1-855-CANALTA

Special Note: the "Contour" and "Canalta Flow Measurement" names and logos are trademarks of Canalta Controls Ltd. "CPA", "50E" and "CPA 50E" are registered trademarks of Canada Pipeline Accessories Co. Ltd. All other trademarks are the property of their respective owners. Canalta implies no endorsement or affiliation with CPA, NOVA, K-Lab or GRI.

Canalta 

Flow Measurement

A Canalta Controls Company

CALL US TOLL FREE: 1-855-CANALTA

TABLE OF CONTENTS

Introduction 4
Design Time Line 5
Flow Conditioner Standards and Specifications 6
Flow Conditioner Design Principles 12
Upstream Length Guidance 16

INTRODUCTION

For more than fifteen years, we at Canalta have worked closely with our customers to provide a variety of flow conditioning solutions to the problem of installation effects on orifice meters. These have included 19-tube bundles in exotic materials, 70D upstream straight runs and a host of flow conditioner designs.

Today we are proud to offer the Contour™ K5 Flow Conditioner, produced in-house to the same stringent quality standards we apply to all of our flow meter products. Canalta offers the Contour K5 in three mounting styles: the **Contour K5F (flange-style)** is mounted between two pipe flanges upstream of the flow meter; the **Contour K5P (pin-style)** is line mounted in the upstream pipe; the **Contour K5+** is mounted in Canalta's patented Flow Conditioner Housing for easy removal, replacement and inspection. We believe this design offers the best available combination of performance, consistency and cost control, providing our flow measurement customers with a complete package of accuracy, reliability and value.

The Contour K5 has its origins in the Novacor flow conditioner development program, which set out to improve the performance of the Laws Flow Conditioner by focusing on velocity profiles exiting the perforated plate. **Ten designs were grouped into two categories: those with an overall solidity of roughly 60% (NOVA-60), and those with a solidity of roughly 50% (NOVA-50).** Researchers have repeatedly found that overall solidity can be critical to flow conditioner performance. While those with higher solidity (above 50%) tend to isolate the flow meter from upstream piping effects (velocity profile generation) very well, pressure loss is significant, and the inverse tends to be true of flow conditioners with lower solidity (below 50%). **Configuration "E" of the NOVA-50 emerged as an effective compromise between the need for ideal, repeatable velocity profiles and limited pressure loss.**

Novacor's performance data was confirmed in a landmark report by the Gas Research Institute (GRI-97/0207) on efforts at Southwest Research Institute to develop objective flow conditioner performance tests. By 2000, AGA-3 / API 14.3 would adopt many of the recommendations of this report, and the excellent performance of the NOVA-50E throughout the SwRI research program meant standards compliance was a forgone conclusion. In 2003, the NOVA-50E* design was adopted into the ISO 5167-1 standard as well.

Throughout the testing, the NOVA-50E* design was covered by the Laws Flow Conditioner Patent. By 1996, K-Lab (Statoil of Norway) had acquired the patent, and in 1997, Canada Pipeline Accessories (CPA®) began to market and manufacture the NOVA-50E* design under license. Between 1998 and 2011, CPA and industry partners would generate broad acceptance of the "CPA-50E*" among North American end users and package fabricators. Canalta alone distributed thousands of flow conditioners with its orifice meters and meter run packages. **The design has become a veritable industry standard for isolating flow meters of several types from upstream piping disturbances.**

In 2011, patent protection expired on the Laws / K-Lab / NOVA-50E design. **With our considerable experience in precision machining and manufacturing flow measurement equipment, we at Canalta decided to bring the NOVA-50E* design into our lineup of OEM flow measurement products under the Contour Flow Conditioning Solutions imprint. By controlling costs and improving quality assurance, we believe that we can increase the value our customers receive from this exceptional flow conditioner design.**

* **Special Note:** the "Contour" and "Canalta Flow Measurement" names and logos are trademarks of Canalta Controls Ltd. "CPA", "50E" and "CPA 50E" are registered trademarks of Canada Pipeline Accessories Co. Ltd. All other trademarks are the property of their respective owners. Canalta implies no endorsement or affiliation with CPA, NOVA, K-Lab or GRI.

TIMELINE OF THE NOVA-50E*(CONTOUR™ K5) DESIGN

FLANGE FACE SERRATED SPIRAL FINISH OF 125µin. TO 250µin.
45-55 GROOVES/in (BOTH SIDES)

Contour™ Flow Conditioners

by **Canalta**

GRI Report 97/0207, a considerable piece of research into flow conditioner performance testing, demonstrates a significant reduction in upstream pipe lengths in orifice meters can be achieved with the NOVA-50E* without significant reductions in pressure, accuracy or reliability.

Novacor Research and Technology Corp. begins work to improve on the Laws Flow Conditioner design. The ultimate goal is to produce accurate, repeatable metering with the shortest possible meter run, regardless of upstream piping configurations. A variety of plate geometries are assessed; the NOVA-50E* design quickly rises to the top.

Measurement Canada certifies the K-Lab / NOVA-50E* (described as the "CPACL") for custody transfer measurement applications in Canada (PS-G-05-E).

A UK patent application is filed for the Laws Flow Conditioner. Patents are eventually granted to Laws / K-Lab by the UK, US, Canada, Austria, the World Patent Office and other states and authorities.
(UK Pat. GB2235064, US Pat. 5,341,848)

Novacor publicizes research data from its flow conditioner development program. Preliminary results showed significant performance improvements compared to the Laws Flow Conditioner and the 19 tube bundle straightening vane. Publicized data from the GRI MRF confirms the Novacor results.

With the Laws / K-Lab patent covering the manufacture of the NOVA-50E*, Canada Pipeline Accessories begins to market and manufacture the 50E* under license.

The Laws / K-Lab US patent covering the NOVA-50E* design expires.

Canalta Flow Measurement launches the Contour series of flow conditioning accessories, notably the Contour K5, based on the NOVA-50E* design. In-house manufacturing allows for lowered costs and improved quality control.



1990

1995

1997

1997 / 1998

2011

2012

1991 - 1999

1999 - Present

2002 - Present

Extensive testing at a variety of centers (NOVA, K-Lab, Southwest Research etc.) is performed on the NOVA-50E* (Contour K5) to establish its performance in orifice meter installations. Generalized results demonstrate the NOVA flow conditioner can successfully reduce upstream pipe lengths by up to 60%.

Testing in both North America and Europe (GRI MRF, GERG, etc.) demonstrates excellent NOVA-50E* (Contour K5) performance in ultrasonic meter installations. European network providers are urged to explore flow conditioner - ultrasonic meter pairings for fiscal gas metering based on this promising data.

CPA* and Canalta Flow Measurement generate broad acceptance and certification of the NOVA-50E* (Contour K5) design among North American end users and meter run / package fabricators.

*The "Contour" name and logo are trademarks of Canalta Controls Ltd. "CPA", "50E" and "CPA 50E" are registered trademarks of Canada Pipeline Accessories Co. Ltd. All other trademarks are the property of their respective owners. Canalta implies no affiliation or endorsement by CPA, Novacor, K-Lab, or GRI.

ContourTM

Flow Conditioners

by **Canalta** 

Flow Conditioner Standards and Specifications

Collated Data Showing NOVA-50E* Compliance
with AGA-3 / API 14.3 (2000 Edition)

Canalta 

Flow Measurement

A Canalta Controls Company

CALL US TOLL FREE: 1-855-CANALTA

NOVA-50E* - AGA-3 COMPLIANCE

Performance Test Specifications

Appendix 2-D of AGA Report No. 3 (2000) sets out the testing parameters by which a flow conditioner is shown to comply with the overall standard. Specifically, these tests aim to “prove that a tested device meets performance criteria within the specified tolerance limits for any type of piping installation upstream of the orifice meter at one line size and for a narrow range of Reynolds numbers (Test D1) or for all line sizes and Reynolds numbers (Test D2).”

Five tests are specified in the standard:

Test 1 - Baseline Calibration using a minimum upstream meter tube length of 70D, swirl-free flow (less than 2°), and using the same orifice plates, β -ratios and measurement equipment as in the remaining four tests.

Test 2 - Good Flow Conditions using either a sliding or fixed position flow conditioner test to show that “the installation or flow conditioner does not degrade the measurement performance of a meter tube under good (baseline) flow conditions.”

Test 3 - Two 90° Elbows in Perpendicular Planes to show that “the installation or flow conditioner can remove normal amounts of swirl and provide good performance in a double out-of-plane elbow installation.”

Test 4 - Gate Valve 50% Closed to show that “the installation or flow conditioner can accept a highly asymmetric profile of axial velocity without degradation of measurement performance.”

Test 5 - High Swirl using a swirl generating device that produces swirl angles of at least $\pm 24^\circ$ at 17D (with confirmation). The objective is to “prove that the flow conditioner is effective in high-swirl environments.”

Performance Test Results

The NOVA-50E has undergone extensive flow testing under a variety of installation configurations. Results collated from several key reports are given for each of the tests below.

Test 1 - Baseline Calibration

Flow conditioner testing reported in Karnik (1995), Morrow (1997) and Karnik et al (1999) all began with baseline calibration using natural gas that met the requirements set out by Appendix 2-D of AGA 3 (2000) (see cited reports for details).

Test 2 - Good Flow Conditions

Morrow (1997) reports performance within specification at flow conditioner - orifice plate intervals of 5D and greater under good flow conditions using natural gas (p. 7, p. 16 fig. 2c) (see below). β -ratio in this test was 0.67.

* **Special Note:** the “Contour” and “Canalta Flow Measurement” names and logos are trademarks of Canalta Controls Ltd. “CPA”, “50E” and “CPA 50E” are registered trademarks of Canada Pipeline Accessories Co. Ltd. All other trademarks are the property of their respective owners. Canalta implies no endorsement or affiliation with CPA, NOVA, K-Lab or GRI.

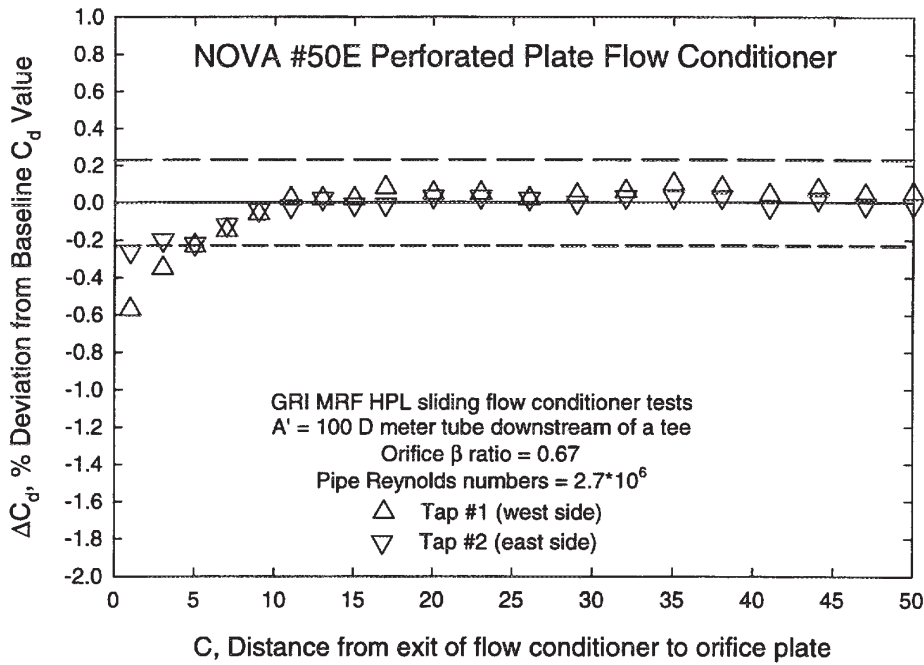

Fig. 2c. Installation effect for NOVA Plate 50E flow conditioner in Good Flow Conditions for $\beta = 0.67$.

Test 3 - Two 90° Elbows in Perpendicular Planes

Morrow (1997) reports performance within specification at flow conditioner - orifice plate intervals of 7D or greater, downstream of two 90° elbows out-of-plane using natural gas. β -ratio for this test matches that of 'good flow conditions' and baseline calibration at 0.67 (p. 8, p. 19 fig. 4c) (see below).

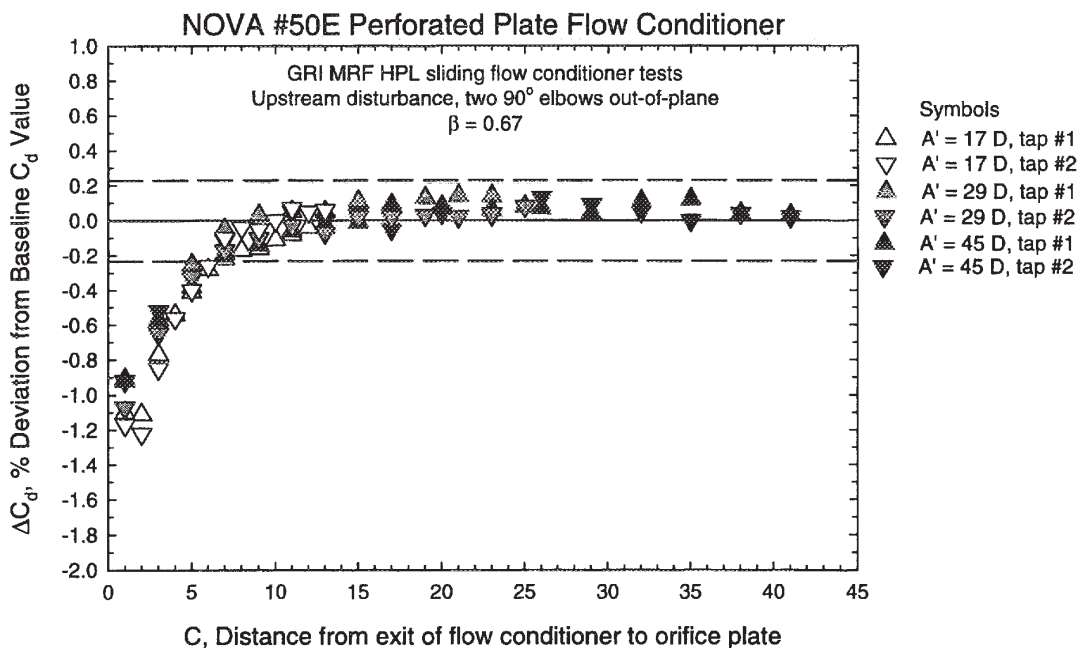

Fig. 4c. Installation effect for NOVA Plate 50E flow conditioner downstream of two 90° elbows "out-of-plane" for $\beta = 0.67$.

Test 4 - Gate Valve 50% Closed

Morrow (1997) reports performance within specification at flow conditioner - orifice plate intervals of 7D or greater, downstream of a half-closed gate valve using natural gas. β -ratio for this test matches that of 'good flow conditions' and baseline calibration at 0.67 (p. 8, p. 22 fig. 6c) (see below).

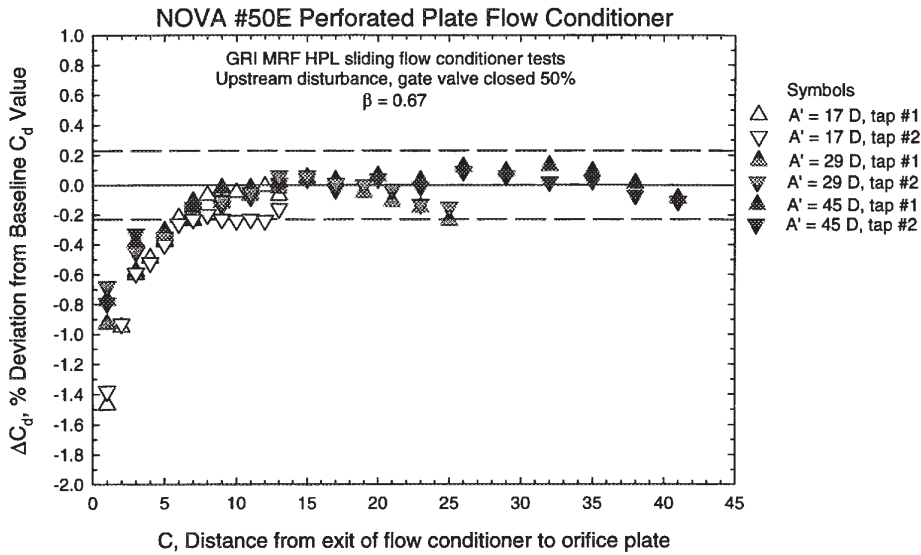

Fig. 6c. Installation effect for NOVA Plate 50E flow conditioner downstream of a gate valve closed 50% for $\beta = 0.67$.

Test 5 - High Swirl

Morrow (1997) reports performance within specification at flow conditioner - orifice plate intervals of 7D or greater, downstream of a swirl generator and tee using natural gas at β -ratio 0.67 (p. 9, p. 26 fig. 4c) (see below).

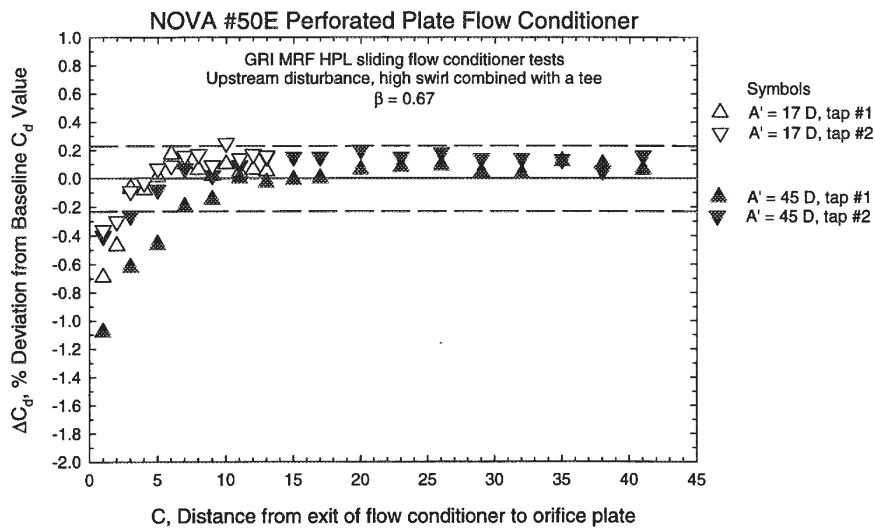

Fig. 9c. Installation effect for NOVA Plate 50E flow conditioner downstream of high swirl and a tee.

Scaling

Appendix 2-D of AGA Report No. 3 (2000) sets out the criteria by which a flow conditioner can be considered to meet specification for all line sizes. Scaling tests include a baseline calibration and one of Tests 3 through 5 (see above) performed on two pipe sizes.

Karnik et al (1999) reports both baseline calibration data and performance results for Test 3 (two 90° elbows out-of-plane) on an 8 inch installation using natural gas as the test medium. The data suggest NOVA-50E performance within specification over a variety of β -ratios at flow conditioner - orifice plate intervals of 7D or greater, particularly at β -ratio 0.67, to correspond with the original disturbance tests on 4 inch installations reported in Morrow (pp. 6-7, Tables 2, 3 and 4).

Reynolds Number Sensitivity

Appendix 2-D of AGA Report No. 3 (2000) stipulates that a baseline calibration and one of Tests 2 through 5 (see above) be performed at one of the line sizes used in the scaling tests, and at two Reynolds numbers at β -ratio 0.67. The low and high Reynolds numbers must fulfill $10^4 \leq Re_l \leq 10^6$ and $Re_h \geq 10^6$.

The specification for tests at a low Reynolds number (Re_l) is satisfied by performance data reported in Karnik (1995). In Test 3 (two elbows out-of-plane) at β -ratio 0.68, deviation from baseline was -0.18% for $Re=1.7 \times 10^5$, and -0.08% for $Re=1.0 \times 10^5$ (p. 16 table 2). These figures were generated on a 12D meter package with a flow conditioner - orifice plate interval of 7D (p. 8) using air as the test medium.

The specification for tests at a high Reynolds number (Re_h) is satisfied by performance data reported in Morrow (1997). In Test 3 at β -ratio 0.67, deviation from baseline was -0.15% (average for pressure taps #1 and #2) for $Re=2.7 \times 10^6$ at a flow conditioner - orifice plate interval of 7D (Appendix B p. B-4.11) using natural gas as the test medium.

Conclusions

Given these results, stakeholders across the spectrum can be confident that these flow conditioners reliably isolate the orifice meter from upstream piping effects, resulting in accurate, repeatable flow metering regardless of installation.

References

American Gas Association Report No. 3 Part 2, *Specification and Installation Requirements* (API 14.3.2), 2000.

Karnik, U. *A Compact Orifice Meter / Flow Conditioner Package*. Proceedings of the 3rd International Symposium on Fluid Flow Measurement, 1995.

Karnik, U.; Studzinski, W.; Geerligs, J.; Kowch, R. *Scale Up Tests on the NOVA Flow Conditioner for Orifice Meter Applications*. Proceedings of the 4th International Symposium on Fluid Flow Measurement, 1999.

Morrow, T.B. *Orifice Meter Installation Effects: Development of a Flow Conditioner Performance Test*. Gas Research Institute Report No. GRI-97/0207, 1997.

ContourTM



Flow Conditioners

by **Canalta** 

Flow Conditioner Design Principles

NOVA-50E* / ContourTM K5

Canalta 

Flow Measurement

A Canalta Controls Company

CALL US TOLL FREE: 1-855-CANALTA

CONTOUR™ K5 DESIGN PRINCIPLES

Canalta has designed the Contour™ K5 Flow Conditioner to precisely match the geometry and dimensioning of the three pitch perforated NOVA #50E*. Extensive testing has shown the NOVA #50E* to successfully isolate the velocity profile from the effects of upstream piping configurations, thereby allowing for accurate, repeatable metering regardless of installation.

Canalta offers the Contour K5 in three mounting styles: the **Contour K5F (flange-style)** is mounted between two pipe flanges upstream of the flow meter; the **Contour K5P (pin-style)** is line mounted in the upstream pipe; the **Contour K5+** is mounted in Canalta’s patented Flow Conditioner Housing for easy removal, replacement and inspection. All three units come standard in 316 stainless steel, with exotic materials such as Monel®, Inconel® and Duplex SS available by special order.

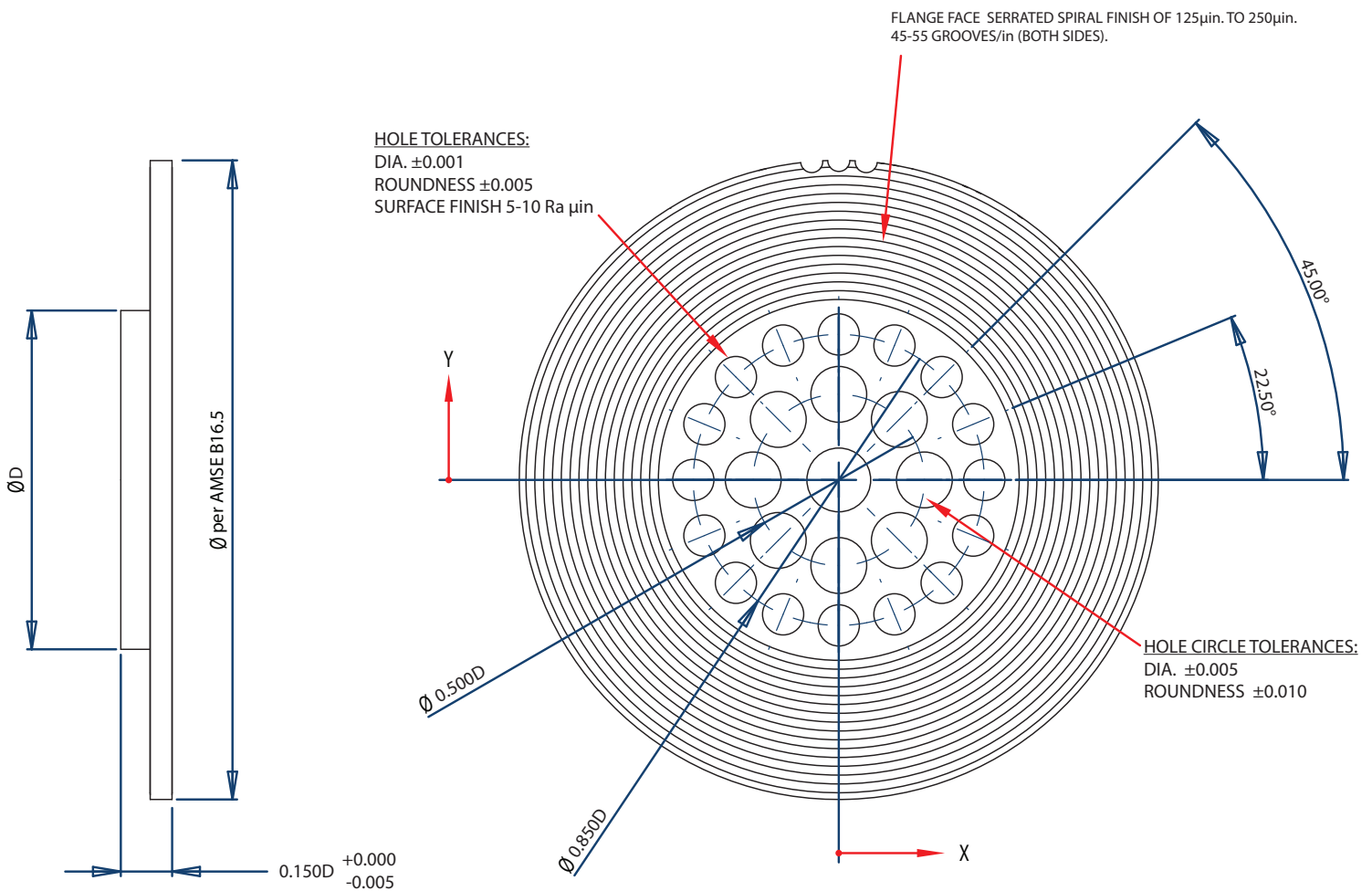

	Number of Holes	Hole Diameter	Hole Circle Diameter
Center	1	0.18629D	n/a
Inner Circle	8	0.163D	0.500D
Outer Circle	16	0.1203D	0.850D

*Original dimensioning can be found in Karnik, U. A Compact Orifice Meter / Flow Conditioner Package (Proceedings of the 3rd International Symposium on Fluid Flow Measurement, 1995) and International Standard ISO 5167-2:2003 Annex B3.

CONTOUR™ K5 QUALITY CONTROL

Like all of our flow measurement equipment, Canalta Flow Measurement makes the quality of our Contour™ Series flow conditioners our top priority. Even slight deviations from the established design of the Contour K5 can affect velocity profile and, ultimately, measurement uncertainty significantly. Below is a sample Q.C. Inspection Report used on our Contour K5 Flow Conditioners.

		Operator : Walter Part Name : 50 contour 1Heat 11114-2156 Part Serial Number : 669RFFC40C50 316SS Units : Inc Time & Date : 09/17/2012 3:36:57 PM			
CONTOUR™ 50F QUALITY CONTROL INSPECTION REPORT					
M_TOP001 (Plane , number of points 4.) 09/17/2012 3:37:25 PM					
	Measured	Nominal	+Tol	-Tol	Out of Tol
Form	0002		0000		*****
M_BOTTOM002 (Plane , number of points 4.) 09/17/2012 3:38:00 PM					
	Measured	Nominal	+Tol	-Tol	Out of Tol
Form	0000		0050		*****
M_A1 (Circle , number of points 4.) 09/17/2012 3:38:35 PM					
	Measured	Nominal	+Tol	-Tol	Out of Tol
Diameter	1.1308	1.1300	0010	-0010	*****
Form	0000		0005		*****
M_B1 (Circle , number of points 4.) 09/17/2012 3:38:47 PM					
	Measured	Nominal	+Tol	-Tol	Out of Tol
Diameter	9894	9890	0010	-0010	*****
Form	0000		0005		*****
M_B2 (Circle , number of points 4.) 09/17/2012 3:38:57 PM					
	Measured	Nominal	+Tol	-Tol	Out of Tol
Diameter	9894	9890	0010	-0010	*****
Form	0001		0005		*****
M_B3 (Circle , number of points 4.) 09/17/2012 3:39:03 PM					
	Measured	Nominal	+Tol	-Tol	Out of Tol
Diameter	9894	9890	0010	-0010	*****
Form	0001		0005		*****
M_B4 (Circle , number of points 4.) 09/17/2012 3:39:13 PM					
	Measured	Nominal	+Tol	-Tol	Out of Tol
Diameter	9891	9890	0010	-0010	*****
Form	0003		0005		*****

M_B5 (Circle , number of points 4.) 09/17/2012 3:39:28 PM					
	Measured	Nominal	+Tol	-Tol	Out of Tol
Diameter	9893	9890	0010	-0010	*****
Form	0002		0005		*****
M_B6 (Circle , number of points 4.) 09/17/2012 3:39:38 PM					
	Measured	Nominal	+Tol	-Tol	Out of Tol
Diameter	9893	9890	0010	-0010	*****
Form	0001		0005		*****
M_B7 (Circle , number of points 4.) 09/17/2012 3:39:48 PM					
	Measured	Nominal	+Tol	-Tol	Out of Tol
Diameter	9892	9890	0010	-0010	*****
Form	0000		0005		*****
M_B8 (Circle , number of points 4.) 09/17/2012 3:40:00 PM					
	Measured	Nominal	+Tol	-Tol	Out of Tol
Diameter	9891	9890	0010	-0010	*****
Form	0002		0005		*****
M_C1 (Circle , number of points 4.) 09/17/2012 3:40:13 PM					
	Measured	Nominal	+Tol	-Tol	Out of Tol
Diameter	7301	7300	0010	-0010	*****
Form	0002		0005		*****
M_C2 (Circle , number of points 4.) 09/17/2012 3:40:23 PM					
	Measured	Nominal	+Tol	-Tol	Out of Tol
Diameter	7302	7300	0010	-0010	*****
Form	0002		0005		*****
M_C3 (Circle , number of points 4.) 09/17/2012 3:40:32 PM					
	Measured	Nominal	+Tol	-Tol	Out of Tol
Diameter	7301	7300	0010	-0010	*****
Form	0002		0005		*****
M_C4 (Circle , number of points 4.) 09/17/2012 3:40:42 PM					
	Measured	Nominal	+Tol	-Tol	Out of Tol
Diameter	7303	7300	0010	-0010	*****
Form	0001		0005		*****
M_C5 (Circle , number of points 4.) 09/17/2012 3:40:52 PM					

	Measured	Nominal	+Tol	-Tol	Out of Tol
Diameter	7303	7300	0010	-0010	*****
Form	0002		0005		*****
M_C6 (Circle , number of points 4.) 09/17/2012 3:41:01 PM					
	Measured	Nominal	+Tol	-Tol	Out of Tol
Diameter	7300	7300	0010	-0010	*****
Form	0001		0005		*****
M_C7 (Circle , number of points 4.) 09/17/2012 3:41:11 PM					
	Measured	Nominal	+Tol	-Tol	Out of Tol
Diameter	7301	7300	0010	-0010	*****
Form	0000		0005		*****
M_C8 (Circle , number of points 4.) 09/17/2012 3:41:21 PM					
	Measured	Nominal	+Tol	-Tol	Out of Tol
Diameter	7301	7300	0010	-0010	*****
Form	0001		0005		*****
M_C9 (Circle , number of points 4.) 09/17/2012 3:41:36 PM					
	Measured	Nominal	+Tol	-Tol	Out of Tol
Diameter	7301	7300	0010	-0010	*****
Form	0002		0005		*****
M_C10 (Circle , number of points 4.) 09/17/2012 3:41:56 PM					
	Measured	Nominal	+Tol	-Tol	Out of Tol
Diameter	7302	7300	0010	-0010	*****
Form	0002		0005		*****
M_C11 (Circle , number of points 4.) 09/17/2012 3:42:06 PM					
	Measured	Nominal	+Tol	-Tol	Out of Tol
Diameter	7302	7300	0010	-0010	*****
Form	0003		0005		*****
M_C12 (Circle , number of points 4.) 09/17/2012 3:42:16 PM					
	Measured	Nominal	+Tol	-Tol	Out of Tol
Diameter	7300	7300	0010	-0010	*****
Form	0002		0005		*****
M_C13 (Circle , number of points 4.) 09/17/2012 3:42:25 PM					

	Measured	Nominal	+Tol	-Tol	Out of Tol
Diameter	7301	7300	0010	-0010	*****
Form	0000		0005		*****
M_C14 (Circle , number of points 4.) 09/17/2012 3:42:37 PM					
	Measured	Nominal	+Tol	-Tol	Out of Tol
Diameter	7303	7300	0010	-0010	*****
Form	0000		0005		*****
M_C15 (Circle , number of points 4.) 09/17/2012 3:42:58 PM					
	Measured	Nominal	+Tol	-Tol	Out of Tol
Diameter	7301	7300	0010	-0010	*****
Form	0001		0005		*****
M_C16 (Circle , number of points 4.) 09/17/2012 3:43:10 PM					
	Measured	Nominal	+Tol	-Tol	Out of Tol
Diameter	7302	7300	0010	-0010	*****
Form	0003		0005		*****
M_BORE (Circle , number of points 4.) 09/17/2012 3:43:30 PM					
	Measured	Nominal	+Tol	-Tol	Out of Tol
Diameter	6.0432	6.0450	0050	-0050	*****
Form	0004		0010		*****
M_OD (Circle , number of points 4.) 09/17/2012 3:43:47 PM					
	Measured	Nominal	+Tol	-Tol	Out of Tol
Diameter	8.4980	8.5000	0050	-0050	*****
Form	0002		0010		*****
C_THICKNESS (Length.) 09/17/2012 3:43:58 PM					
	Measured	Nominal	+Tol	-Tol	Out of Tol
Length	9094	9100	0000	-0050	*****
C_PITCH CIRCLE 1 (Circle , number of points 8.) 09/17/2012 3:44:17 PM					
	Measured	Nominal	+Tol	-Tol	Out of Tol
Diameter	3.0028	3.0030	0050	-0050	*****
Form	0003		0100		*****
C_PITCH CIRCLE 2 (Circle , number of points 16.) 09/17/2012 3:44:18 PM					
	Measured	Nominal	+Tol	-Tol	Out of Tol
Diameter	5.1500	5.1550	0050	-0050	*****
Form	0006		0100		*****

Contour™

Flow Conditioners

by **Canalta** ➤

GUIDANCE FOR FLOW METER INSTALLATIONS

The **Contour™ K5 Flow Conditioner** effectively isolates the flow meter from upstream installation effects, significantly reducing upstream length requirements. Cost, size and weight are reduced without significant drops in pressure, accuracy or reliability.

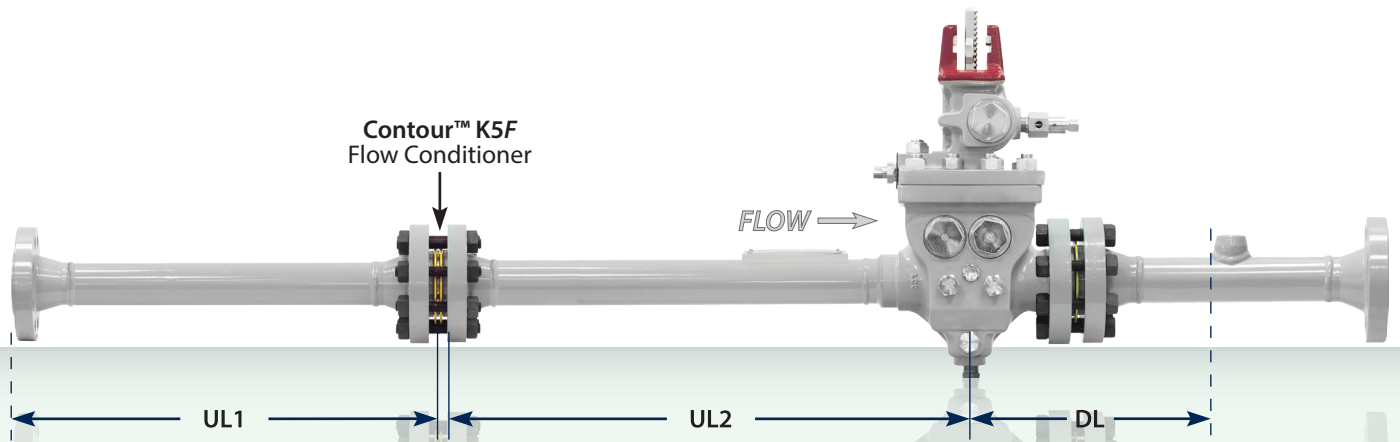

- UL1 should include a **minimum 5D** of unbroken straight pipe measured from the upstream face of the Contour K5 Flow Conditioner. Greater lengths are acceptable.
- UL2 should include a **minimum 8D** of unbroken straight pipe measured from the downstream face of the Contour K5 Flow Conditioner to the upstream face of the orifice plate. Greater lengths are acceptable.
- The 8D / 5D minimums described here are acceptable for orifice meters, ultrasonics, venturis, flow nozzles, turbine meters or any other metering element susceptible to installation effects.

Test data supporting these guidelines is available. Ensure your meter run package addresses all applicable factors. For assistance in meter run design, or to discuss AGA / ISO standards compliance, please contact Canalta Flow Measurement directly.

Call Us Toll Free: 1-855-CANALTA

Canalta ➤

Flow Measurement

A Canalta Controls Company