

Palmer Circular Chart Recorders

Pressure & Temperature Recorders

Designed for indoor or outdoor use, our recorders provide long service life, even in harsh conditions.



Proven reliability for your toughest application.

Versatility that adapts to your needs.

Internal Assemblies, Clocks and Parts

- All internal components are corrosion resistant.
- Each recorder may contain up to three (3) felt tip pens.
- Pen assembly is designed to transmit the movement of the sensors into a smooth, gliding arc across the chart. This prevents burrowing, resulting in longer pen life and better accuracy.
- Micro adjustment feature simplifies calibration.
- Wire linkage.
- Palmer PC-11 multi-speed battery operated chart drive is standard. Electric (115 or 220V and 60 or 50 Hertz), or Spring Wound optional. Rotation periods include 24 and 48 hours and 7, 8, 30, 31 and 32 days.
- Charts sold separately.

Case and Door Features

- Made of heavy aluminum, die cast and heat treated to prevent distortion or warping. Two sizes: 8 and 12 inch charts.
- Weather tight glass window and door (plexiglass window, solid door, and door stop optional).
- Pressure Recorders have 1/2" diameter air vent holes in case.
- Draw pull latch with hasp for padlock (Double Latch Bar with padlock type handle, solid door included optional).
- White Power Coating finish standard, other colors available.
- Temperature and/or pressure connections are located at the back, top, or bottom of case, depending on mounting style:
 - Wall mounted
 - Flush mounted
 - Pipestand mounted
 - Pedestal mounted
 - Portable

**IP55
COMPLIANT**

THREE YEAR
3
WARRANTY



PALMER Wahl

INSTRUMENTATION GROUP

Building Recorders in the USA since 1962

Circular Chart Recorders

Pressure & Temperature Recorders

Palmer Recorders are available in 8" or 12" models, and come complete with either electric, spring wound, or PC-11 (battery operated) chart drive, and up to three (3) felt tip pens. Case mountings are wall, flush, pedestal, pipestand or portable. The combinations of case mounts and internals allow selections which meet your specific requirements without limiting performance or demanding a custom price.

Pressure Recorders

Pressure ranges up to 0 to 10,000 psig are offered in both 8" and 12" chart recorders.

Recorder accuracy is $\pm 1/2$ chart graduation.

Temperature Recorders

Temperature ranges from -40°F to 1000°F in both 8" and 12" recorders.

Recorder accuracy is ± 1 chart graduation.

Pressure & Temperature Recorders

Temperature and pressure can be combined inside the same recorder with up to three (3) pens.

Dimensions	8in		12in	
	in	mm	in	mm
A	10-9/16	268.3	13-1/16	331.8
B	4-1/4	107.9	4-1/2	114.3
C	14-1/2	361.9	16-3/8	415.9
D	13-5/8	346.0	15-13/16	401.6
E	10-5/16	261.9	12-13/16	325.4
F	13-7/16	341.3	15-9/16	395.3

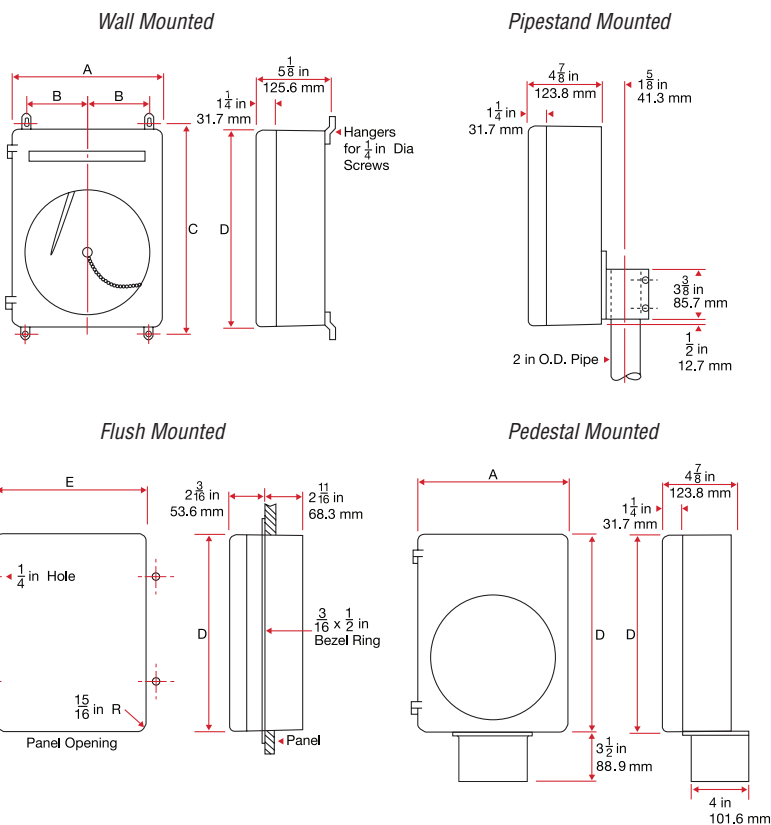

PC-11 Quartz Multi-Speed Chart Drive

11 Speeds offer complete flexibility for recording in the most demanding applications

Designed for outdoor use, Palmer's hermetically sealed PC-11 operates reliably even in wet and dirty environments. Freezer tested to -40°F , it will withstand extreme temperatures. The highly adaptable design will fit any chart recorder, and makes exchange in the field a snap.

The eleven speed dial on the front of the case allows field selectable recording intervals from 60 minutes to 32 days. The dial also turns the unit off to conserve battery power. A pulsating LED indicator behind the dial shows that the battery is charged and that the unit is operating.

Our PC-11 is rated intrinsically safe, which makes it ideal for use by gas utility companies and in other situations where hazardous or combustible materials are present.



PC-11

- **11 Speeds:** switch selectable, choose from 60 min., 96 min., 12 hr., 1 day, 2 day, 7 day, 8 day, 14 day, 16 day, 31 day or 32 day recording intervals
- **Universal Mounting Bracket:** fits all chart recorders for easy replacement
- **.25" Drive Shaft:** With flat, accepts different drive hubs
- **High Torque:** 25 oz/in torque increases life and improves accuracy
- **No Axial or Angular Backlash:** charts don't shift
- **Broad Operating Temperature Range:** -40°F to 160°F
- **Battery Choice:** 3.5 lithium battery, can be exchanged for 1.5 volt "C" battery when PC-11 is used in very cold conditions
- **Molded Body Pilot:** Permits field exchange without recalibration
- **Maintenance-Free:** Closed construction case protects all moving parts
- **Separate Battery Compartment:** prevent drive damage from corrosion
- **UL Listed:** Class I, Groups C and D, Intrinsically Safe, CSA Certified

Pressure and Temperature Elements

Pressure Elements

Each Palmer pressure element is individually designed and calibrated for one service pressure range. Palmer subjects these elements to extensive testing during calibration to ensure better than specified accuracy. The all-welded system prevents deterioration.

- Accuracy $\pm 1/2$ chart graduation
- 316 S.S. helical type coil with S.S. fittings and tubing, all welded construction offers over-range protection for ranges over 30 PSIG (Ranges under 10,000 PSI with 1/4" NPT female connection, ranges 10,000 PSI and above with F-250-C Autoclave style fitting.)
- Beryllium copper diaphragm silver brazed to copper tubing and brass fittings for ranges under 30 PSIG (with 1/4" NPT female connection)
- Angular deflection of the pen arm of 22-1/2 degrees for 8" and 36 degrees for 12"
- Standard ranges to 30,000 PSI. For higher ranges please call factory.



High pressure helical wound bourdon coil for ranges over 30 PSIG

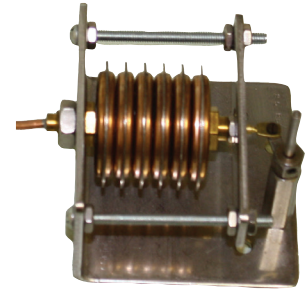

Low pressure diaphragm for ranges under 30 PSIG

Temperature Elements

Palmer's temperature recorder elements must pass stringent quality control. All mercury filled systems conform to ASME and other designations such as 5A or 5B. Each system is pressurized after filling so it will have overrange capabilities above and below its specified range. Rapid response to changes in temperature make it extremely accurate and reliable. The system is completely welded to prevent deterioration. Points most susceptible to physical damage are reinforced with added flexible armor.

- Accuracy ± 1 chart graduation
- Carefully heat treated coil provides superior spring action
- Durable, low maintenance design: thermal system and other parts easily replaced by field technician
- 300 Series stainless steel bulb, interconnection capillary, and armor available on certain designs
- Standard case compensated system for uncompensated capillary lengths not exceeding 25'



Temperature recorder element

**Our filled system expertise
results in an extremely
long life thermal system.**

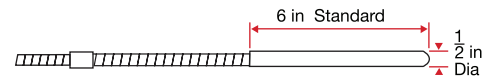

Bulb 45-5
Plain bulb of stainless steel

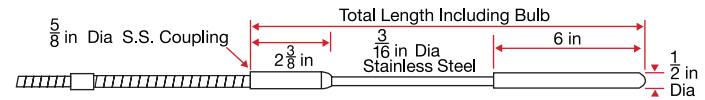

Bulb 45-11
Bendable stiff armor between plain bulb and flexible armor

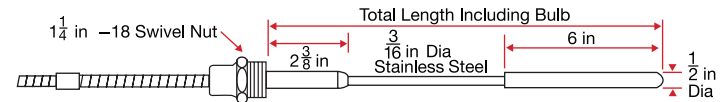

Bulb 45-12
Bendable stiff armor between plain bulb and swivel nut

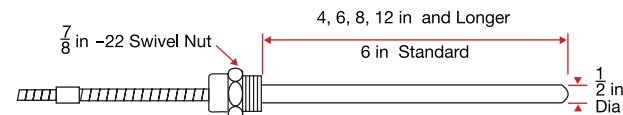

Bulb 45-13
Bulb for well or union connection

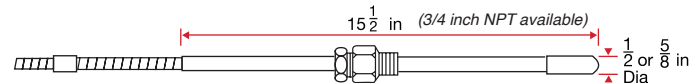

Bulb 45-14 standard
Bulb construction permits instrument to be used in wells of varied lengths

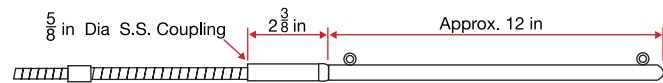

Bulb 45-29
Plain air temperature bulb with rings for suspending in air stream

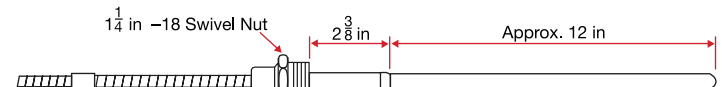

Bulb 45-30
Air temperature bulb for union connection

Note: Air type bulbs have standard outside diameter of 5/16" and 3/8".



Temperature recorders contain mercury and may be restricted for sale in some states. Contact Customer Service for more information.



How to Order a Palmer Recorder

Wall Mount - Furnished with armored capillary or pressure connection at the bottom of case unless otherwise specified.

Flush Mount - Furnished with armored capillary or pressure connection at the back of the case. Front door latch standard.

Pipestand Mount - Furnished with armored capillary or pressure connection at the bottom of case unless otherwise specified.

Portable - Supplied with flexible armor or pressure connection at the back of the case unless otherwise specified.

Pedestal Mount - Flexible armored capillary or pressure connection may be furnished at the back, top or bottom of case if specified in the customer's order.

Specifications subject to change without notice.



Wall Mount - Code 2



Flush Mount - Code 3



Pipestand Mount - Code 4



Portable - Code 5



Pedestal Mount - Code 8

Additional Ordering Requirements

- Range
- Lens, Door, and Latch Style
- Number of Pens/Color
- Chart Drives
- Rotation Period
- Charts (not included, 5 box min)
- Pressure Element
- Temperature System
- Cable Length (5 ft standard)

Recorders Selection Guide

Order additional requirements as separate line item
Operating and maintenance manuals are included with all models.

Code	Type of Measurement
1	Pressure
2	Temperature
3	Pressure/Temperature (2 Pen)
4	Pressure with Valve & Test Connection

Code	Recorder Case Size
2	12" Chart Case
8	8" Chart Case

Code	Case Mounting
2	Wall Mount
3	Flush Mount
4	Pipestand Mount
5	Portable
8	Pedestal Mount

2 8 4 Typical Recorder Configuration

Model 284 Recorder is an 8" Case, Temperature Recorder with Pipestand Mounting

IP55 COMPLIANT

THREE YEAR
3
WARRANTY

MADE IN THE USA

Palmer can custom build to meet your special requirements.
Call 1-800-421-2853

Palmer recorders are hand-crafted to last longer than any other product in the market.

Pressure Ranges - from 0 to 30,000 psig are offered in both 8" and 12" chart recorders. Recorder accuracy is $\pm 1/2$ " chart graduation.

Pressure Recorder Ranges	
0 / 15	0 / 800
0 / 30	0 / 1000
0 / 50	0 / 1500
0 / 60	0 / 2000
0 / 100	0 / 2500
0 / 120	0 / 3000
0 / 150	0 / 4000
0 / 200	0 / 5000
0 / 250	0 / 6000
0 / 300	0 / 7000
0 / 350	0 / 8000
0 / 400	0 / 10,000
0 / 500	0 / 15,000
0 / 600	0 / 20,000
0 / 750	0 / 30,000

Note: Other ranges available upon request

Temperature Ranges - from -40°F to 1000°F are offered in both 8" and 12" chart recorders. Recorder accuracy is ± 1 chart graduation.

Temperature Recorder Ranges		
Range	Degree Divisions	Degree Numbered
-30° / 70°F	1°	5°
60° / 90°F	2°	10°
0° / 100°F	2°	10°
-40° / 110°F	2°	10°
-30° / 120°F	2°	10°
0° / 120°F	2°	10°
0° / 150°F	2°	10°
-40° / 160°F	2°	10°
60° / 160°F	1°	5°
30° / 240°F	2°	10°
0° / 250°F	5°	25°
100° / 250°F	2°	10°

Temperature Recorder Ranges		
Range	Degree Divisions	Degree Numbered
0° / 300°F	5°	25°
0° / 375°F	5°	25°
0° / 400°F	5°	25°
50° / 400°F	1°	5°
0° / 500°F	10°	50°
0° / 600°F	10°	50°
100° / 600°F	5°	25°
0° / 750°F	10°	50°
0° / 800°F	10°	50°
0° / 1000°F	20°	100°
200° / 1000°F	10°	50°

Note: Other ranges available upon request
Celsius equivalents also available

234 Old Weaverville Road • Asheville, North Carolina • 28804-1260
Phone: 800-421-2853 • 828-658-3131 • Fax: 828-658-0728 • Email: info@palmerwahl.com

PALMER

INSTRUMENTS, INC.

NEW! Palmer Pelican Case Portable Chart Recorder for Tough Outdoor Environments



Chart stays dry regardless of the weather!

**IP67
COMPLIANT**

Solid Door

NEW! Palmer Pelican® Case Recorder - our top quality 8" chart recorder now comes housed in a rugged Pelican case. Double-throw latches and water-tight O-ring seal assures IP67 protection even in harsh environments. Lightweight and easy to carry, the new Palmer Pelican Case Recorder offers the convenience and protection you need in a recorder.

Palmer Chart Recorders come complete with either PC-11 (battery operated) chart drive as standard, or optional spring wound. Temperature and Pressure can be combined inside the same recorder with up to three (3) systems. Palmer Recorders are made in the USA!

Case Features

- Watertight, Crushproof, and Dust proof.
- Plexiglass Window (Std) or optional Solid Door.
- Double Throw Latches and Watertight O-ring Seals.
- Open cell core with solid wall design - strong and light weight.
- Automatic Pressure Equalization Valve releases built-up pressure and prevents moisture intrusion.
- Comfortable rubber over-molded handle.
- Stainless Steel padlock protectors provide extra strength when locking against tamper resistance.
- Heavy Duty Deflector Ribs to protect against shock and impact.
- NO SLIP rubberized adjustable feet, keep recorder balanced.

Recorder Features

- All internal components are corrosion resistant.
- Pen assembly is designed to transmit the movement of the sensors into a smooth, gliding arc across the chart. This prevents burrowing, resulting in longer pen life and better accuracy and readability.
- Micro adjustment feature simplifies calibration.
- Wire linkage.

Recorder Specifications

Pressure Ranges: inH₂O Ranges from 0 to 100, Hg Ranges from 0 to 50, kPa Ranges from 0 to 5,000, oz/in² Ranges from 0 to 50, PSI Ranges from 0 to 30,000.

Accuracy: ± 1/2 chart graduation.

Pressure Elements: High pressure helical wound bourdon coil for ranges over 30 PSIG, Low pressure diaphragm for ranges under 30 PSIG.

Temperature Ranges: from 0°F to 1000°F, and 0° to 600°C.

Accuracy: ± 1 chart graduation.

Temperature Elements: Mercury filled systems, the most accurate in the world, conform to ASME, and 5A and 5B, and offer rapid response to temperature changes.

Pens: Fine point, felt tip pens in Red, Green and Blue. Other colors available.

Chart Drives: PC-11 Battery Operated Chart Drive (Std) - 11 speeds allows selectable recording intervals from 60 min., 96 min., 12 hr., 1 day, 2 day, 7 day, 8 day, 14 day, 16 day, 31 day or 32 day recording intervals. Hermetically sealed, Intrinsically safe. Spring Wound: 24 hours and 7 days, or optional 15 minute and 1 hour.

Chart: 1 Box of Charts included.

Case Dimensions (Exterior, without Handle and Feet): 18.5" x 14.06" x 6.93" (47 x 35.7 x 17.6 cm)

Case Weight (Empty): 6.39 lbs (2.9 kg)



PALMER Wahl

INSTRUMENTATION GROUP
Continued Innovation Since 1836

ISO 9001:2008 CERTIFIED

(800) 421-2853 • FAX (828) 658-0728 • www.palmerwahl.com

PW1181
October 2015

NEW! Palmer Pelican Case Portable Chart Recorder

Temperature Elements

Palmer's temperature elements must pass stringent quality control. All mercury filled systems conform to ASME and other designations such as 5A or 5B. Each system is pressurized after filling so it will have overrange capabilities above and below its specified range. Rapid response to changes in temperature make it extremely accurate and reliable. The system is completely welded to prevent deterioration. Points most susceptible to physical damage are reinforced with added flexible armor.

- Carefully heat treated coil provides superior spring action
- Durable, low maintenance design: thermal system and other parts easily replaced by field technician
- 300 Series stainless steel bulb, interconnection capillary, and armor available on certain designs
- Standard case compensated system for uncompensated capillary lengths not exceeding 25'.
- Standard ranges: from 0°F to 1000°F, and 0° to 600°C.

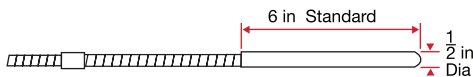

Bulb 45-5
Plain bulb of stainless steel

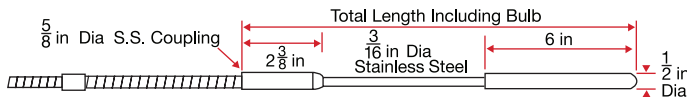

Bulb 45-11
Bendable stiff armor between plain bulb and flexible armor

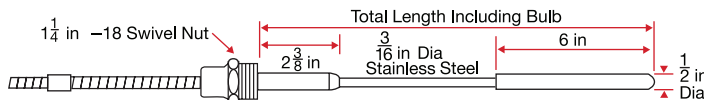

Bulb 45-12
Bendable stiff armor between plain bulb and swivel nut

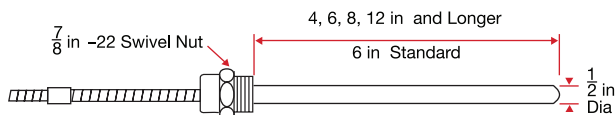

Bulb 45-13
Bulb for well or union connection

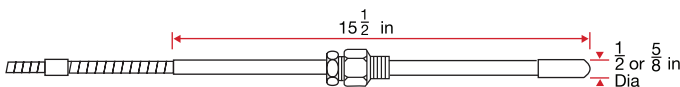

Bulb 45-14 standard
Bulb construction permits instrument to be used in wells of varied lengths

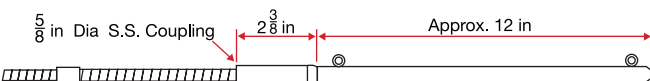

Bulb 45-29
Plain air temperature bulb with rings for suspending in air stream

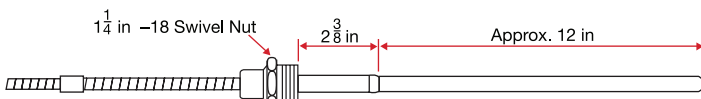

Bulb 45-30
Air temperature bulb for union connection

Note: Air type bulbs have standard outside diameter of 5/16" and 3/8".



Pressure Elements

Each Palmer pressure element is individually designed and calibrated for one service pressure range to ensure better than specified accuracy. The all-welded system prevents deterioration.

- 316 S.S. helical type coil with S.S. fittings and tubing, all welded construction offers over-range protection for ranges over 30 PSIG. Ranges up to 10,000 PSI have a 1/4" NPT female connection. Ranges above 10,000 PSI have a 9/16"-18 UNF Female Autoclave Engineers Fitting with a 60 Degree conical seat. (Optional on 10,000 PSI).
- Beryllium copper diaphragm silver brazed to copper tubing and brass fittings for ranges under 30 PSIG (with 1/4" NPT female connection).
- Angular deflection of the pen arm of 22-1/2 degrees for 8" and 36 degrees for 12".
- Standard ranges: inH₂O Ranges from 0 to 100, Hg Ranges from 0 to 50, kPa Ranges from 0 to 5,000, oz/in² Ranges from 0 to 50, PSI Ranges from 0 to 30,000.

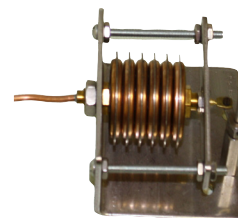

Low pressure diaphragm for ranges under 30 PSIG



High pressure helical wound bourdon coil for ranges over 30 PSIG

Palmer recorders are hand-crafted in the USA to last longer than any other product on the market!



PALMER Wahl
INSTRUMENTATION GROUP
Continued Innovation Since 1836
ISO 9001:2008 CERTIFIED